

# ME Offshore Swing Door Latch

## Mortise locking

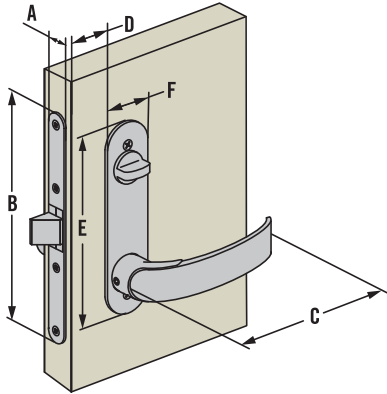

### Mortise Privacy Locking



	Imperial		Metric
	Nominal	Decimal	
A	31/64	.492	12.5
B	5 5/16	5.31	135
C	3 15/16	3.94	100
D	39/64	.61	15.5
E	4 37/64	4.59	116
F	1 3/16	1.18	30

- All marine-grade materials for corrosion resistance
- Mortise mount installation
- Interior privacy lock with exterior override

### Material and Finish

Lock engine: Aluminum  
 Handles, escutcheons finish: chrome, aluminum and black  
 Privacy: Acetal

### Panel Preparation

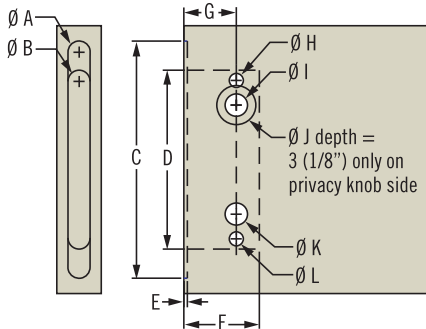

	Imperial		Metric
	Nominal	Decimal	
A	1/2	.50	12.5
B	1/2	.50	12.5
C	5 5/16	5.31	135
D	4	4	102
E	1/16	.06	1.5
F	1 11/16	1.69	43
G	1 11/64	1.17	30
H	5/16	.31	8
I	1/2	.50	12
J	7/8	.88	22
K	1/2	.50	12
L	5/16	.31	8

### Part Number Selection

**ME - 02 - D L T - FF**

**D Directional**  
 2 Right Out  
 3 Right In  
 4 Left Out  
 5 Left In

**L Locking Option**  
 0 Privacy  
 1 Key Locking

**T Door Thickness**  
 4 18-22mm (11/16" - 7/8")  
 5 22-27mm (7/8" - 1 1/16")  
 6 27-32mm (1 1/6" - 1 1/4")  
 7 32-37mm (1 1/4" - 1 1/2")

**FF Finish**  
 10 Chrome  
 50 Black  
 60 Aluminum

For strikers see page 615

### D Directional Door Swing:

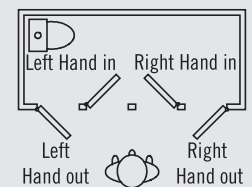

# MC Striker

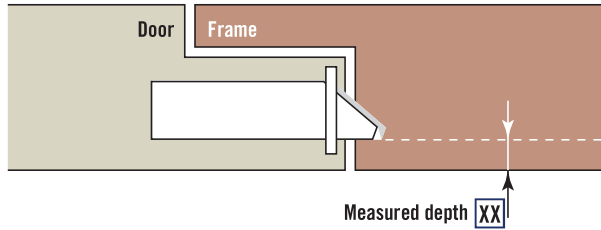
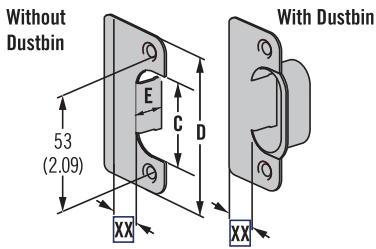

To find the right striker for your application, measure the distance from the door face to the edge of the springbolt of the latch.

C		D		E	
Metric	Imperial	Metric	Imperial	Metric	Imperial
36	1 7/16	68	2 11/16	13	1/2

## Part Number Selection

**MC - 90 - Z XX - FF**

**Z Dustbin Option**  
 1 No Dustbin  
 2 With Dustbin

**XX Position**  
 03 3mm (7/64")    13 13mm (1/2")  
 05 5mm (3/16")    16 16mm (5/8")  
 07 7mm (1/4")    21 21mm (7/8")  
 09 9mm (3/8")

**FF Finish**  
 10 Brass, nickel plated  
 24 Stainless steel

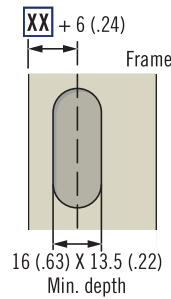

- Available in seven different sizes
- Suitable for Offshore, McCoy, Compact, and Omni swing door latches and many door and frame configurations and door thicknesses
- Striker tongue prevents wear from boat vibration
- Optional dustbin hides sawdust in the cut out hole and provides an elegant finish to the frame edge

[www.southco.com/MC](http://www.southco.com/MC)

# MC Whale Striker

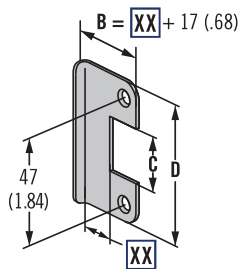

C		D	
Metric	Imperial	Metric	Imperial
60	2 3/8	22	7/8

## Part Number Selection

**MC - 90 - 3 - XX - FF**

**XX Position**  
 03 3mm (7/64")    13 13mm (1/2")  
 05 5mm (3/16")    16 16mm (5/8")  
 07 7mm (1/4")    21 21mm (7/8")  
 09 9mm (3/8")

**FF Finish**  
 10 Brass, nickel plated

- Suitable for Offshore, McCoy and Compact swing door latches.
- Quick and easy installation